

Components

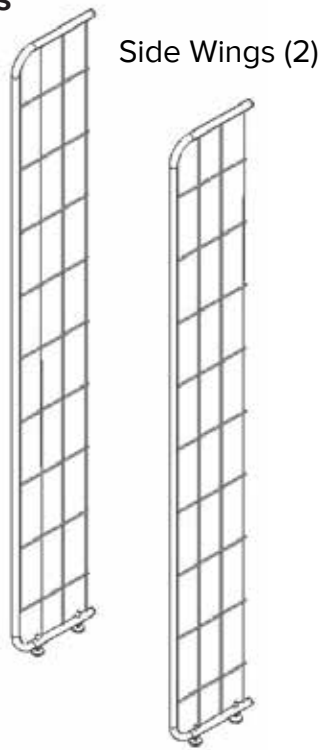

Back Panel Assembly (1)

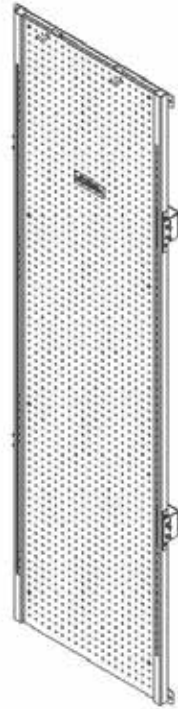

Shelves (6)

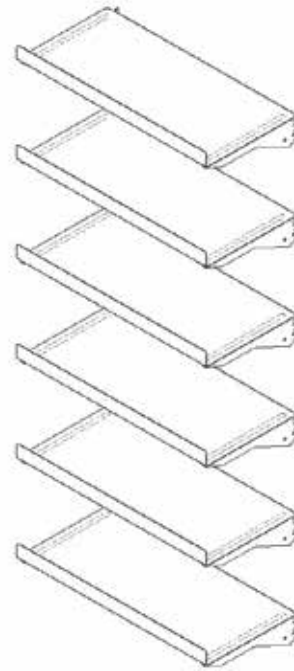

Flange Bolt (4)



1 Assemble Unit

Install 4 bolts through the Back Panel Assembly into the steel tubes of the Side Wings. Install shelves into upright slots at desired position.

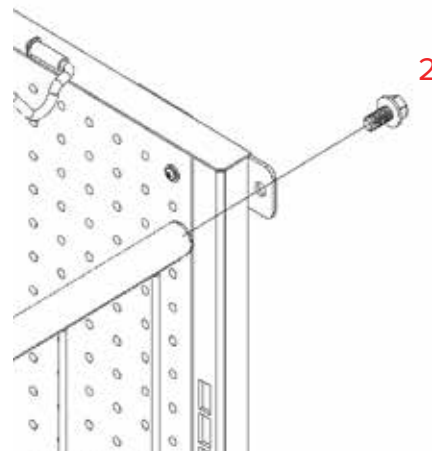
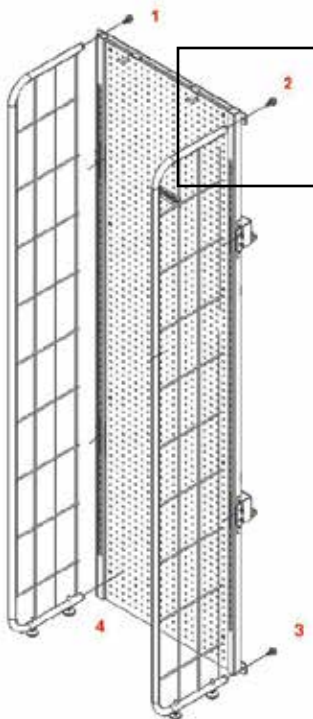

Install shelves into upright slots at desired position.

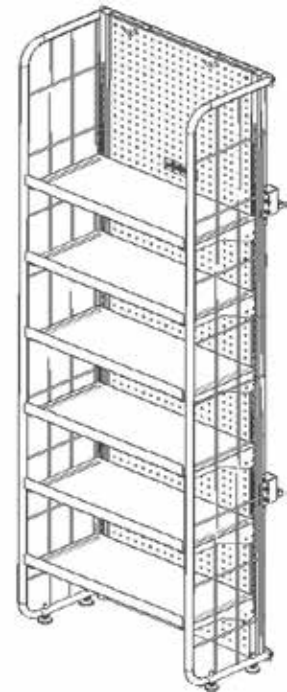

20190523

2 Attach to Gondola

Position Sidekick unit up against the side of a standard gondola (Lozier or Madix). Slide mounting attachments (at both top and bottom of unit) up and insert teeth into gondola upright slots. Once unit is mounted correctly to gondola, push the locking tabs into the slots and tighten the thumbscrews.

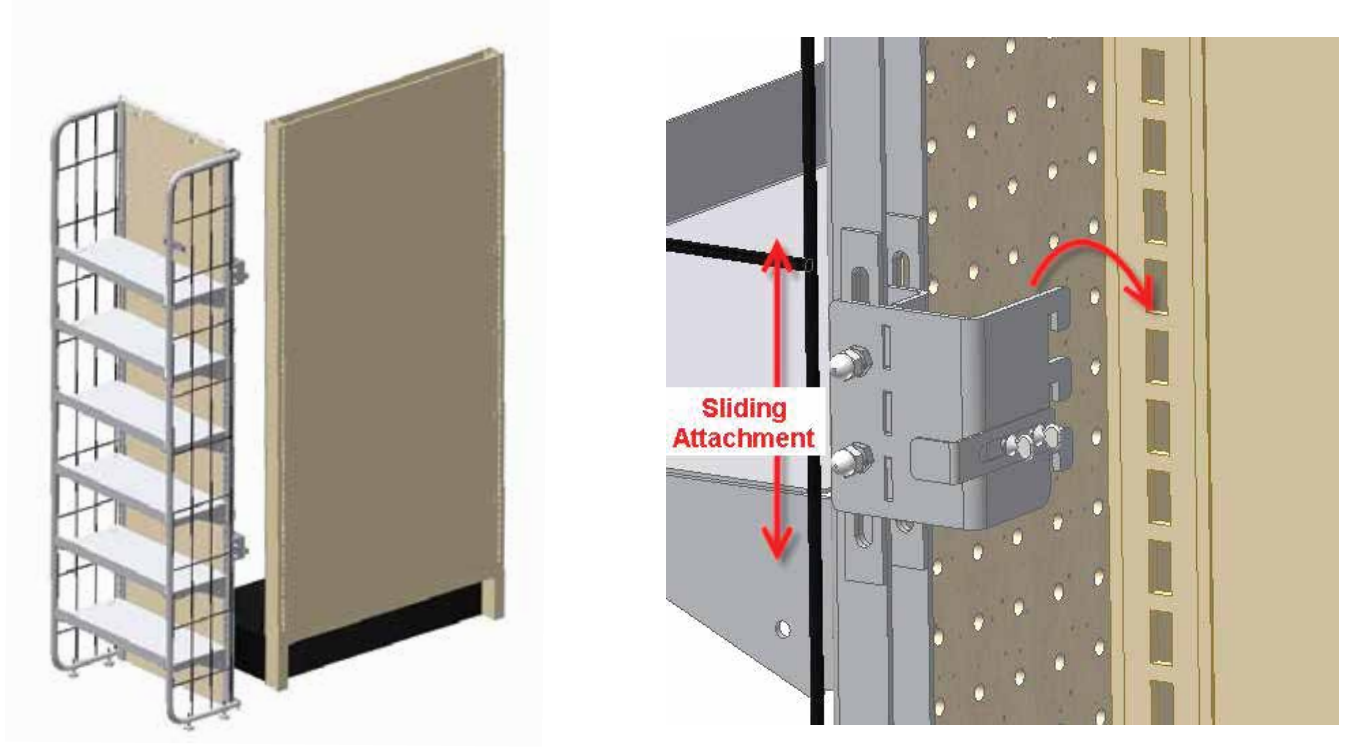

3 Finished Condition

The sidekick unit is designed to attach to the gondola on either the left or right side. Once installed correctly, the opposite side's sliding mount attachment can be removed if desired.

WARNING: TIP OVER HAZARD

If the Sidekick unit is not mounted properly to the gondola, unit may tip over and cause serious injury.



20190523